

## GPS & GLONASS Antenna Module



### 1. Product Information

1.1 Product Name: YIC51515GMSGG-33

#### 1.2 Product Description:

YIC51515GMSGG-33 is a complete standalone GPS/GNSS antenna module. It can simultaneously acquire and track multiple satellite constellations that include GPS, GLONASS, GALILEO, QZSS and SBAS. It features low power and small form factor.

YIC51515GMSGG-33 is suitable for the following applications:

- Automotive navigation
- Personal positioning
- Fleet management
- Mobile phone navigation
- Marine navigation

#### 1.3 Product Features

- MediaTek high sensitivity solution
- Support 99-channel (33 Tracking, 99 Acquisition)
- Ultra low power consumption
- Fast TTFF at low signal level
- Built-in 12 multi-tone active interference canceller
- Free hybrid ephemeris prediction to achieve faster cold start
- Built-in data logger
- Built-in DC/DC converter to save power
- Up to 10 Hz update rate
- $\pm 1$ ns high accuracy time pulse (1PPS)
- Capable of SBAS (WAAS, EGNOS, MSAS, GAGAN)
- Support Japan QZSS
- Indoor and outdoor multi-path detection and compensation
- SMD type with stamp holes
- RoHS compliant

## 1.4 Product Specifications

### GNSS Performance

GNSS Receiver		
Chip	MediaTek MT3333	
Frequency	GPS, GALILEO, QZSS: L1 1575.42MHz, C/A code GLONASS: L1 1598.0625MHz ~ 1605.375MHz, C/A code	
Channels	Support 99 channels (33 Tracking, 99 Acquisition)	
Update rate	1Hz default, up to 10Hz	
Sensitivity	Tracking	-161dBm, up to -165dBm (with external LNA)
	Cold start	-142.5dBm, up to -148dBm (with external LNA)
Acquisition Time	Hot start (Open Sky)	< 1s
	Cold Start (Open Sky)	< 33s
		< 15s with AGPS
Position Accuracy	Autonomous	3m (2D RMS).
	SBAS	2.5m (depends on accuracy of correction data).
Max. Altitude	< 18,000 m, up to 50,000m by request	
Max. Velocity	Velocity < 515 m/s	
Protocol Support	NMEA 0183	9600 bps, 8 data bits, no parity, 1 stop bits (default) 1Hz: GGA, GLL, GSA, GSV, RMC, VTG
Physical Characteristic		
Dimensions	15.5mm * 15.5 mm * 6.7mm(H)	

## 1.5 DC Electrical characteristics

Parameter	Symbol	Conditions	Min.	Typ.	Max.	Units
Input Voltage	VCC		2.8	3.3	4.3	V
Input Backup Battery Voltage	V_BCKP		2.0		3.6	V
Supply Current	Iss	VCC = 3.3V, w/o active antenna, Peak			150 <sup>(1)</sup>	mA
		Acquisition		35		mA
		Tracking		32 <sup>(2)</sup>		mA
		Standby		280		uA
Backup Battery Current	Ibat	VCC = 0V		7		uA
High Level Input Voltage	VIH		2.0		3.6	V
Low Level Input Voltage	VIL		-0.3		0.8	V
High Level Input Current	IIH	no pull-up or down	-1		1	uA
Low Level Input Current	IIL	no pull-up or down	-1		1	uA
High Level Output Voltage	VOH		2.4		3.3	V
Low Level Output Voltage	VOL				0.4	V
High Level Output Current	IOH			2		mA
Low Level Output Current	IOL			2		mA

**Note 1:** This happens when downloading AGPS data to Module.

**Note 2:** Measured when position fix (1Hz) is available, input voltage is 3.3V and the function of self-generated ephemeris prediction is inactive.

## 1.6 Temperature characteristics

Parameter	Symbol	Min.	Typ.	Max.	Units
Operating Temperature	Topr	-40	25	85	°C
Storage Temperature	Tstg	-40	25	85	°C

## 2. Technical Information

### 2.1 Module Pin Assignment

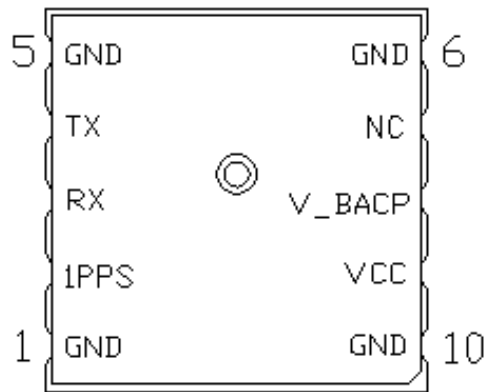

Top view

Pin No.	Pin name	Type	Description	Remark
1	GND	P	Ground	
2	1PPS	O	Pulse per second (default 100ms pulse/sec when 3D fix is available)	
3	RX	I	Serial data input	
4	TX	O	Serial data output	
5	GND	P	Ground	
6	GND	P	Ground	
7	NC		No connection	
8	V_BCKP	P	Backup battery supply voltage (2.0V~3.6V)	
9	VCC	P	DC Supply voltage (2.8V~4.3V)	
10	GND	P	Ground	

## 2.2Dimensions

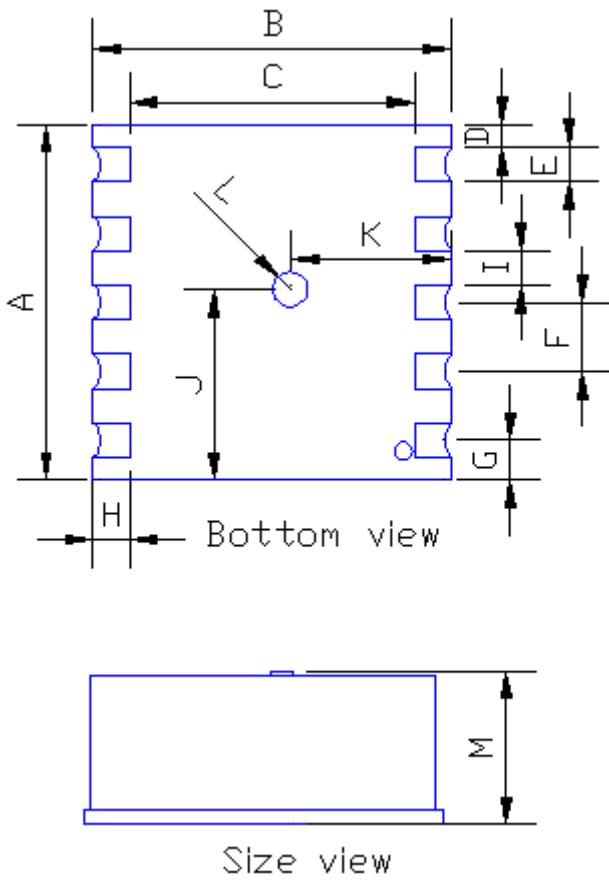

Parameter	Specification
A	15.5+0.3mm/-0.1mm
B	15.5±0.1mm
C	12.4±0.1mm
D	1±0.1mm
E	1.5±0.1mm
F	3±0.1mm
G	1.75±0.1mm
H	1.6±0.1mm
I	1.5±0.1mm
J	8.3±0.1mm
K	7.0±0.1mm
L	φ 1.5±0.1mm
M	6.7±0.2mm
Weight	28g

### 3. NMEA 0183 Protocol

The NMEA protocol is an ASCII-based protocol, Records start with a \$ and with carriage return/line feed. GPS specific messages all start with \$GPxxx where xxx is a three-letter identifier of the message data that follows. NMEA messages have a checksum, which allows detection of corrupted data transfers.

YIC51515GMSGG-33 modules support the following NMEA-0183 messages: GGA, GLL, GSA, GSV, RMC and VTG.

Table3. 1: NMEA-0183 Output Messages

NMEA Record	DESCRIPTION
GGA	Global positioning system fixed data
GLL	Geographic position—latitude/longitude
GSA	GNSS DOP and active satellites
GSV	GNSS satellites in view
RMC	Recommended minimum specific GNSS data
VTG	Course over ground and ground speed

#### GGA-Global Positioning System Fixed Data

Table3. 2 contains the values of the following example:

\$GPGGA,183015.000,2503.7123,N,12138.7446,E,2,16,0.68,123.2,M,15.3,M,0000,0000\*66

Table3. 2: GGA Data Format

Name	Example	Units	Description
Message ID	\$GPGGA		GGA protocol header
UTC Position	183015.000		hhmmss.sss
Latitude	2503.7123		ddmm.mmmm
N/S indicator	N		N=north or S=south
Longitude	12138.7446		dddmm.mmmm
E/W Indicator	E		E=east or W=west
Position Fix Indicator	2		See Table 2-1
Satellites Used	16		Range 0 to 33
HDOP	0.68		Horizontal Dilution of Precision
MSL Altitude	123.2	meters	
Units	M	meters	
Geoids Separation	15.3	meters	
Units	M	meters	
Age of Diff. Corr.	0000	second	Null fields when DGPS is not Used
Diff. Ref. Station ID	0000		
Checksum	*66		
<CR><LF>			End of message termination

Table3. 2.1: Position Fix Indicators

Value	Description
0	Fix not available or invalid
1	GPS SPS Mode, fix valid
2	Differential GPS, SPS Mode, fix valid
3-5	Not supported
6	Dead Reckoning Mode, fix valid

## GLL-Geographic Position – Latitude/Longitude

Table3. 3 contains the values of the following example:

\$GPGLL , 3723.24755, N,12158.34161,W,161229.487, A,D\*2C.

Table 3.3: GLL Data Format

Name	Example	Units	Description
Message ID	\$GPGLL		GLL protocol header
Latitude	3723.24755		ddmm.mmmmm
N/S Indicator	N		N=north or S=south
Longitude	12158.34161		dddmm.mmmmm
E/W Indicator	W		E=east or W=west
UTC Position	161229.487		hhmmss.sss
Status	A		A=data valid or V=data not valid
Mode	D		A=autonomous, D=DGPS, E=DR, N=Data not valid,R=Coarse Position, S=Simulator
Checksum	*2C		
<CR><LF>			End of message termination

## GSA-GNSS DOP and Active Satellites

Table3. 4 contains the values of the following example:

```
$GNGSA,A,3,18,193,21,09,12,22,27,15,25,14,,1.44,0.68,1.27*2F
```

```
$GNGSA,A,3,76,72,77,75,66,65,,,,,1.44,0.68,1.27*12
```

Table3. 4: GSA Data Format

Name	Example	Units	Description
Message ID	\$GNGSA		GSA protocol header
Mode 1	A		See Table 4-2
Mode 2	3		See Table 4-1
ID of satellite used	18		Sv on Channel 1
ID of satellite used	193		Sv on Channel 2
...	...		...
ID of satellite used			Sv on Channel 12
PDOP	1.44		Position Dilution of Precision
HDOP	0.68		Horizontal Dilution of Precision
VDOP	1.27		Vertical Dilution of Precision
Checksum	*2F		
<CR><LF>			End of message termination

Table3. 4.1: Mode 1

Value	Description
1	Fix not available
2	2D
3	3D

Table3. 4.2: Mode 2

Value	Description
M	Manual-forced to operate in 2D or 3D mode
A	Automatic-allowed to automatically switch 2D/3D



### GSV-GNSS Satellites in View

Table3. 5 contains the values of the following example:

\$GPGSV,3,1,11,18,67,344,48,09,55,031,50,42,54,142,40,193,47,174,45\*4D

\$GPGSV,3,2,11,21,44,219,46,27,39,035,48,12,34,131,44,15,30,057,46\*76

\$GPGSV,3,3,11,22,27,319,47,14,22,285,42,25,19,171,40\*44

\$GLGSV,2,1,07,76,71,201,44,65,57,041,40,75,48,028,39,72,27,108,39\*68

\$GLGSV,2,2,07,66,25,333,43,77,17,207,37,81,02,280,29\*5C

Table3. 5: GSV Data Format

Name	Example	Units	Description
Message ID	\$GPGSV		GSV protocol header (GPGSV and GLGSV)
Number of Message <sup>(1)</sup>	3		Range 1 to 6
Message Number <sup>(1)</sup>	1		Range 1 to 6
Satellites in View	11		
Satellite ID	18		Channel 1(Range 1 to 196)
Elevation	67	degrees	Channel 1(Range 0 to 90)
Azinmuth	344	degrees	Channel 1( Range 0 to 359)
SNR(C/NO)	48	dBHz	Channel 1( Range 0 to 99,null when not tracking)
...			...
Satellite ID	09		Channel 4(Range 1 to 196)
Elevation	55	degrees	Channel 4(Range 0 to 90)
Azimuth	031	degrees	Channel 4( Range 0 to 359)
SNR(C/NO)	50	dBHz	Channel 4( Range 0 to 99, null when not tracking)
Checksum	*4D		
<CR><LF>			End of message termination

**Note1:** Depending on the number of satellites tracked multiple messages of GSV data may berequired

## RMC-Recommended Minimum Specific GNSS Data

Table 3.6 contains the values of the following example:

\$GNRMC,183015.000,A,2503.7123,N,12138.7446,E,0.01,34.92,270812,,D\*43

Table3. 6: RMC Data Format

Name	Example	Units	Description
Message ID	\$GNRMC		RMC protocol header (GNRMC or GPRMC)
UTS Position	183015.000		hhmmss.sss
Status	A		A=data valid or V=data not valid
Latitude	2503.7123		ddmm.mmmm
N/S Indicator	N		N=north or S=south
Longitude	12138.7446		dddmm.mmmm
E/W Indicator	E		E=east or W=west
Speed Over Ground	0.01	Knots	True
Course OverGround	34.92	Degrees	
Date	270812		ddmmyy
Magnetic variation		Degrees	
Variation sense			E=east or W=west (Not shown)
Mode	D		A=autonomous, D=DGPS, E=DR, N=Data not valid, R=Coarse Position, S=Simulator
Checksum	*43		
<CR><LF>			End of message termination

## VTG-Course Over Ground and Ground Speed

Table3.7 contains the values of the following example:

\$GPVTG,34.92,T,,M,0.01,N,0.02,K,D\*07

Table3 . 7: VTG Data Format

Name	Example	Units	Description
Message ID	\$GPVTG		VTG protocol header
Course	34.92	Degrees	Measured heading
Reference	T		True
Course		Degrees	Measured heading
Reference	M		Magnetic
Speed	0.01	Knots	Measured horizontal speed
Units	N		Knots
Speed	0.02	Km/hr	Measured horizontal speed
Units	K		Kilometer per hour
Mode	D		A=autonomous, D=DGPS, E=DR, N=Data not valid,R=Coarse Position, S=Simulator
Checksum	*07		
<CR><LF>			End of message termination