

# YIC

## **GNSS Industry Solution**

[service@yic.com.tw](mailto:service@yic.com.tw)





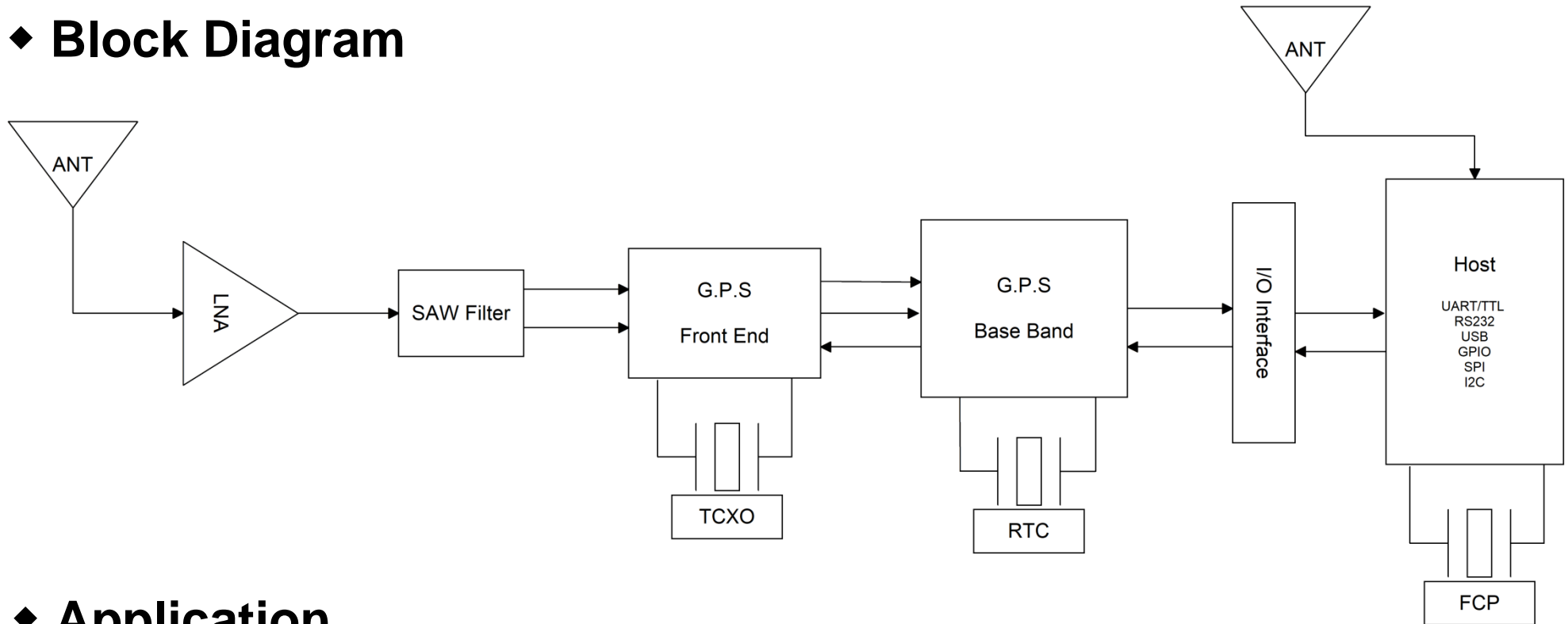



[www.yic.com.tw](http://www.yic.com.tw)

## ◆ Block Diagram



## ◆ Application

Vehicle Tracking	GPS Timing	Geographical measurement	Healthcare	Logistics Navigation
Marine Navigation	Personal / Asset / Pet / cattle	Precision Agriculture	Aviation	Wearable and Portable

Image	GNSS Product	Product Series
	GPS / GNSS Module	YIC5xxxxEB, YIC3xxxxEB, YIC7xxxxEB, YIC9xxxxEB
	GPS / GNSS Antenna Module	YIC5xxxxGM, YIC3xxxxGM, YIC7xxxxGM, YIC9xxxxGM
	GPS / GNSS Receiver (G-Mouse)	Gx-502 , Gx-504, Gx-302, Gx-902, Gx-904
	GPS / GNSS Patch Antenna	ATPG series
	GPS / GNSS Internal Active Antenna	ATIG series
	GPS / GNSS External Active Antenna	ATG series
Image	Other Product	Product Series
	Frequency Control Product (FCP)	XTAL, XO, VCXO, TCXO, OCXO, SAW
	RF Antenna	External Active, Internal PCB, Internal FPC 5G, 4G LTE, Wi-Fi, ISM, Combo, ....