

## GPS/GNSS Receiver Module

### 1. Product Information

#### 1.1 Product Name: YIC51612EB-37



#### 1.2 Product Description

YIC51612EB-37 features high sensitivity, low power and ultra small form factor. The module is powered by MediaTek. It can provide you with superior sensitivity and performance even in urban canyon and dense foliage environment. The miniature size makes the module easy to integrate into portable device like mobile phone, PDAs, camera and vehicle locators.

This module supports hybrid ephemeris prediction to achieve faster cold start. One is self-generated ephemeris prediction that is no need of both network assistance and host CPU's intervention. This is valid for up to 3 days and updates automatically from time to time when GPS module is powered on and satellites are available. The other is server-generated ephemeris prediction that gets from an internet server. This is valid for up to 14 days. Both ephemeris predictions are stored in the on-board flash memory and perform a cold start time less than 15 seconds.

YIC51612EB-37 is suitable for the following applications:

- Automotive navigation
- Personal positioning
- Fleet management
- Mobile phone navigation
- Marine navigation

## 1.3 Product Features

- MediaTek high sensitivity solution
- Support 66-channel GPS
- Ultra low power consumption
- Fast TTFF at low signal level
- Built-in 12 multi-tone active interference canceller
- Free hybrid ephemeris prediction to achieve faster cold start
- Built-in DC/DC converter to save power
- Up to 10 Hz update rate
- $\pm 1$  ns high accuracy time pulse (1PPS)
- Capable of SBAS (WAAS, EGNOS, MSAS, GAGAN)
- Support Japan QZSS
- Indoor and outdoor multi-path detection and compensation
- Small form factor 16.0 \* 12.2 \* 2.2 mm
- SMD type with stamp holes
- RoHS compliant

## 1.4 Product Specifications

### GNSS Receiver

GPS Receiver		
Chip	MediaTek MT3337(ROM)	
Frequency	L1 1575.42MHz, C/A code	
Channels	Support 66 channels/22 tracking	
Update rate	1Hz default, up to 10Hz	
Sensitivity	Tracking	-162dBm, up to -165dBm (with external LNA)
	Cold Start	-143.5dBm, up to -148dBm (with external LNA)
Acquisition Time	Hot start (Open Sky)	< 1s (typical)
	Hot start (Indoor)	< 30s
	Cold Start (Open Sky)	38s (typical) without AGPS
< 15s (typical) with AGPS (hybrid ephemeris prediction)		
Position Accuracy	Autonomous	3m (2D RMS)
	SBAS	2.5m (depends on accuracy of correction data)
Max. Altitude	< 18,000 m	
Max. Velocity	< 515 m/s	
Protocol Support	NMEA 0183	9600 bps, 8 data bits, no parity, 1 stop bits (default)
		1Hz: GGA, GLL, GSA, GSV, RMC, VTG
Physical Characteristic		
Type	24pin stamp holes	
Dimensions	16.0mm * 12.2 mm * 2.2mm ±0.2mm	

## 1.5 DC Electrical Characteristics

Parameter	Symbol	Conditions	Min.	Typ.	Max.	Units
Input Voltage	VCC		3.0	3.3	4.3	V
Input Backup Battery Voltage	V_BCKP		2.0		4.3	V
Supply Current	I <sub>ss</sub>	VCC = 3.3V, w/o active antenna, Peak Acquisition Tracking Standby		31 24 <sup>(2)</sup> 600	150 <sup>(1)</sup>	mA mA mA uA
Backup Battery Current	I <sub>bat</sub>	VCC = 0V		7		uA
High Level Input Voltage	V <sub>IH</sub>		2.0		3.6	V
Low Level Input Voltage	V <sub>IL</sub>		-0.3		0.8	V
High Level Input Current	I <sub>IH</sub>	no pull-up or down	-1		1	uA
Low Level Input Current	I <sub>IL</sub>	no pull-up or down	-1		1	uA
High Level Output Voltage	V <sub>OH</sub>		2.4		3.3	V
Low Level Output Voltage	V <sub>OL</sub>				0.4	V
High Level Output Current	I <sub>OH</sub>			2		mA
Low Level Output Current	I <sub>OL</sub>			2		mA

**Note 1:** This happens when downloading AGPS data to XBDM-1612.

**Note 2:** Measured when position fix (1Hz) is available, input voltage is 3.3V and the function of self-generated ephemeris prediction is inactive.

### Temperature characteristics

Parameter	Symbol	Min.	Typ.	Max.	Units
Operating Temperature	T <sub>opr</sub>	-40	25	85	°C
Storage Temperature	T <sub>stg</sub>	-40	25	85	°C

## 2. Block Diagram

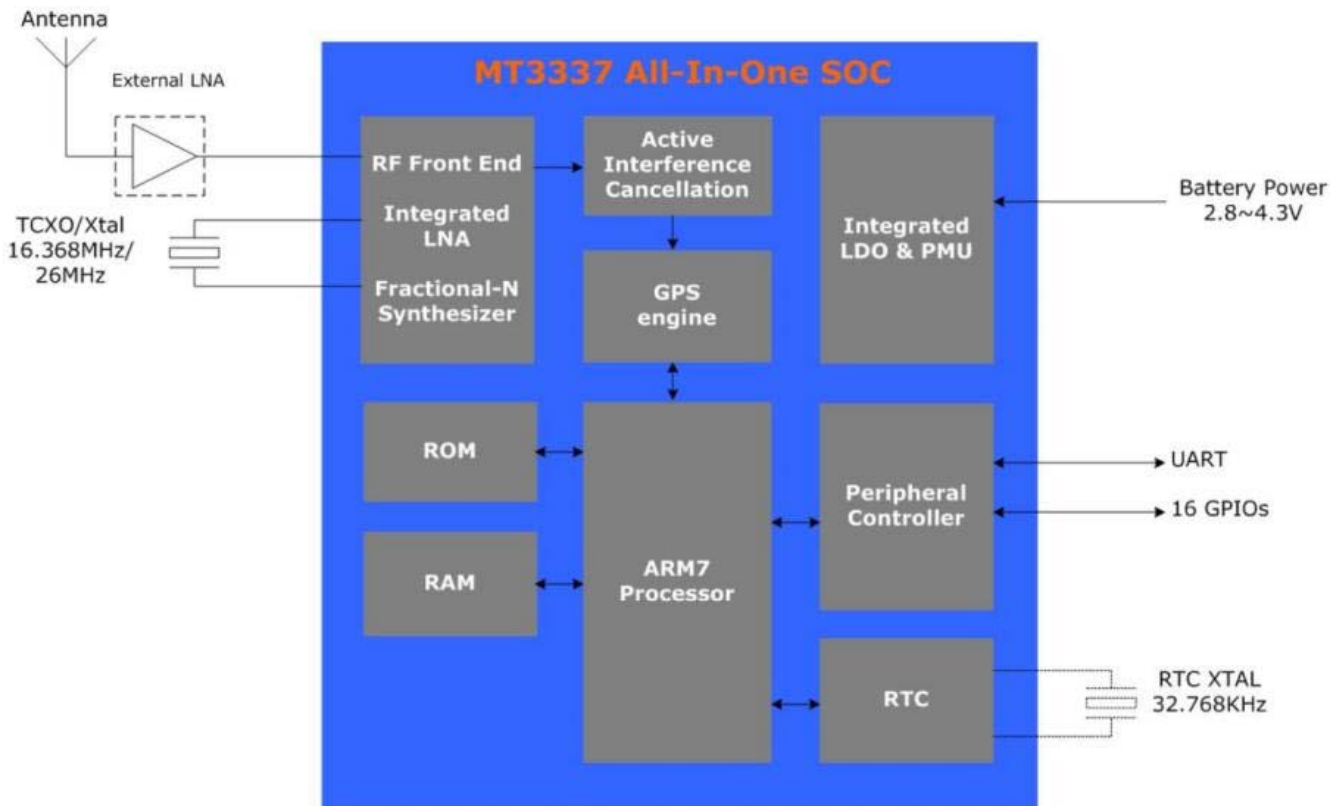

## 3. Module Pin Assignment

13	GND	GND	12
14	NC	RF_IN	11
15	NC	GND	10
16	NC	RF_VCC	9
17	NC	NC	8
18	NC	NC	7
19	NC	NC	6
20	TXD	NC	5
21	RXD	NC	4
22	V_BAT	TIMEPULSE	3
23	VCC	NC	2
24	GND	NC	1

Pin NO.	Pin Name	I/O	Remark
1.	NC	N	Not Connect
2.	NC	N	Not Connect
3.	TIMEPULSE	I/O	One pulse per second.
4.	NC	N	Not Connect
5.	NC	N	Not Connect
6.	NC	N	Not Connect
7.	NC	N	Not Connect
8.	NC	N	Not Connect
9.	RF_VCC	O	Output voltage for active antenna
10.	GND	G	Ground.
11.	RF_IN	I	GNSS Signal Input
12.	GND	G	Ground.
13.	GND	G	Ground.
14.	NC	N	Not Connect
15.	NC	N	Not Connect
16.	NC	N	Not Connect
17.	NC	N	Not Connect
18.	NC	N	Not Connect
19.	NC	N	Not Connect
20.	TXD	O	Serial output (Default NMEA)
21.	RXD	I	Serial input (Default NMEA)
22.	V_BAT	P	Backup battery supply voltage <b>This pin must be powered to enable the module.</b>
23.	VCC	P	DC supply voltage
24.	GND	G	Ground.

## 4. Dimensions

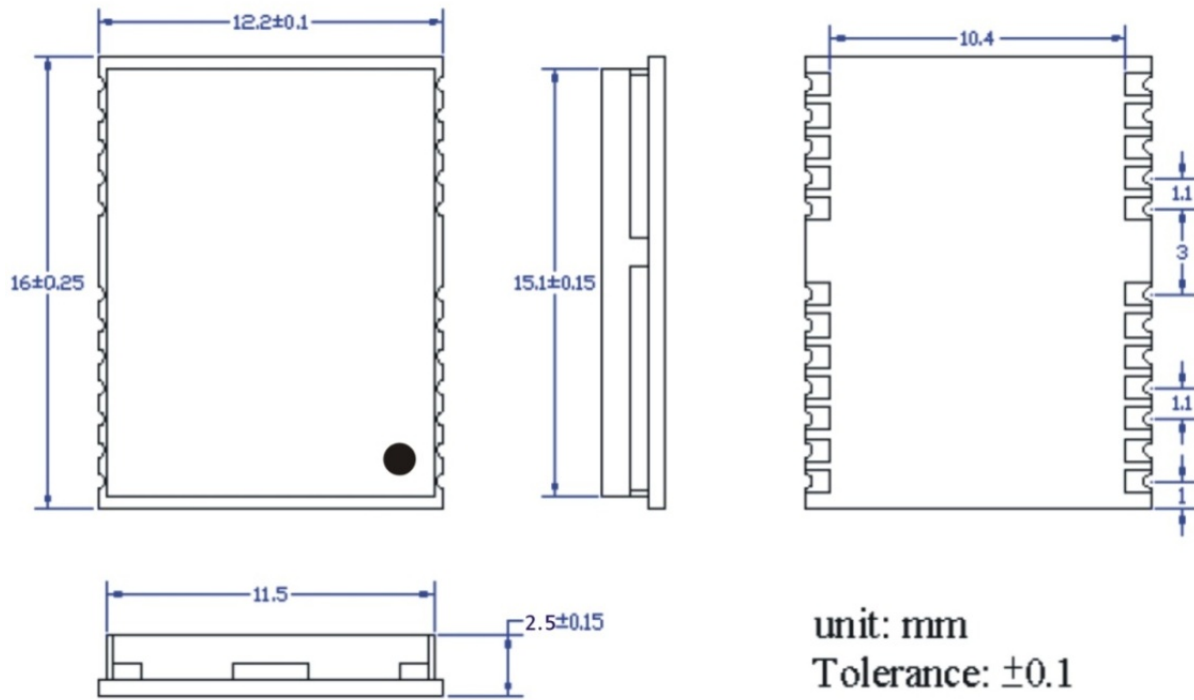

## 5. Recommended Footprint

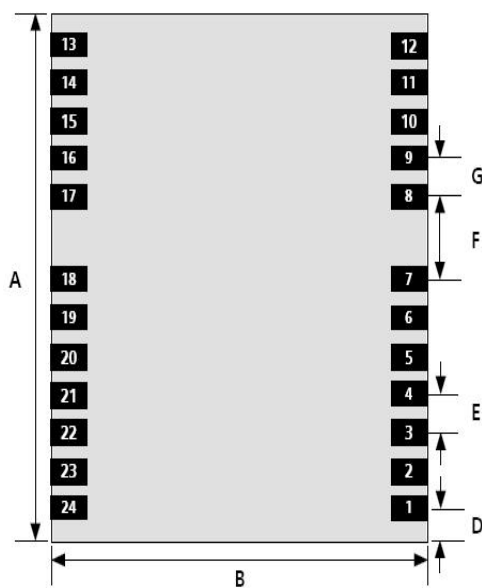

Parameter	Specification	
A	$16.0 +0.6/-0.1$ mm	[628.8 +24/-4mil]
B	$12.2 \pm 0.1$ mm	[479.5 $\pm 4$ mil]
C	$2.4 \pm 0.2$ mm	[94.3 $\pm 8$ mil]
D	$1.0 +0.3/-0.1$ mm	[39.3 +18/-4mil]
E	$1.1 \pm 0.1$ mm	[43.2 $\pm 4$ mil]
F	$3.0 \pm 0.1$ mm	[117.9 $\pm 4$ mil]
G	$1.1 \pm 0.1$ mm	[43.2 $\pm 4$ mil]
Weight	1.6 g	

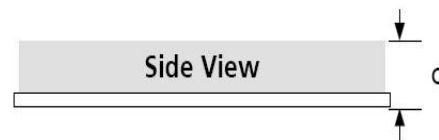

## 6. Application Circuit

### 6.1 With Active Antenna

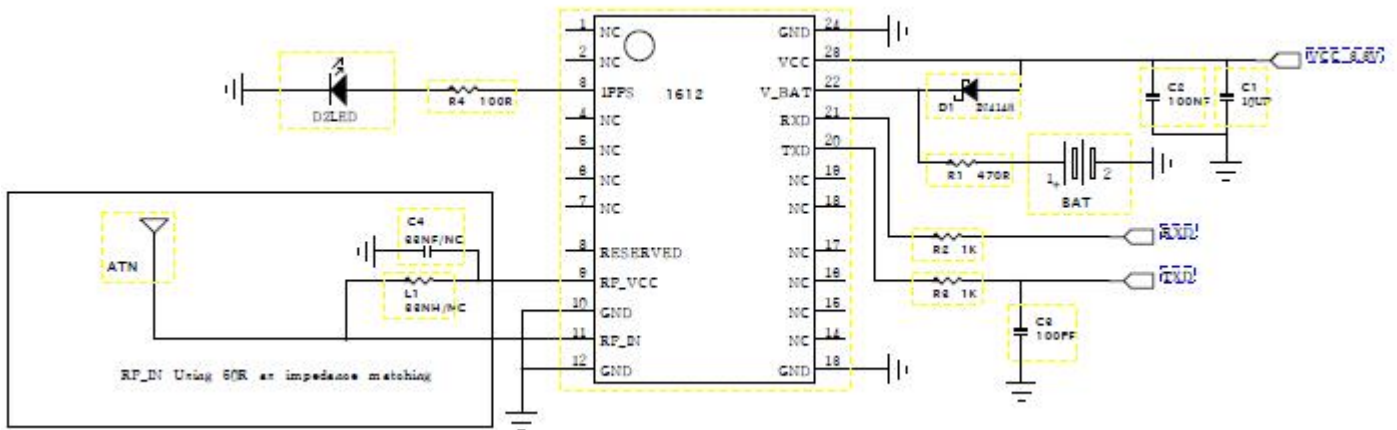

### 6.2 With Passive Antenna, LNA & SAW Filter

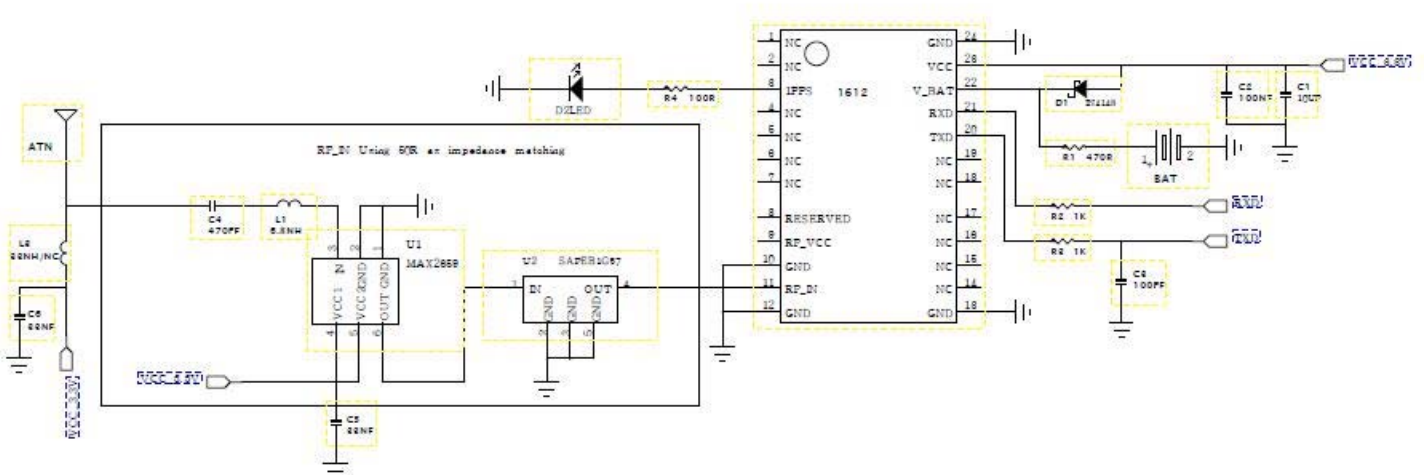



## 7. Reflow Profile

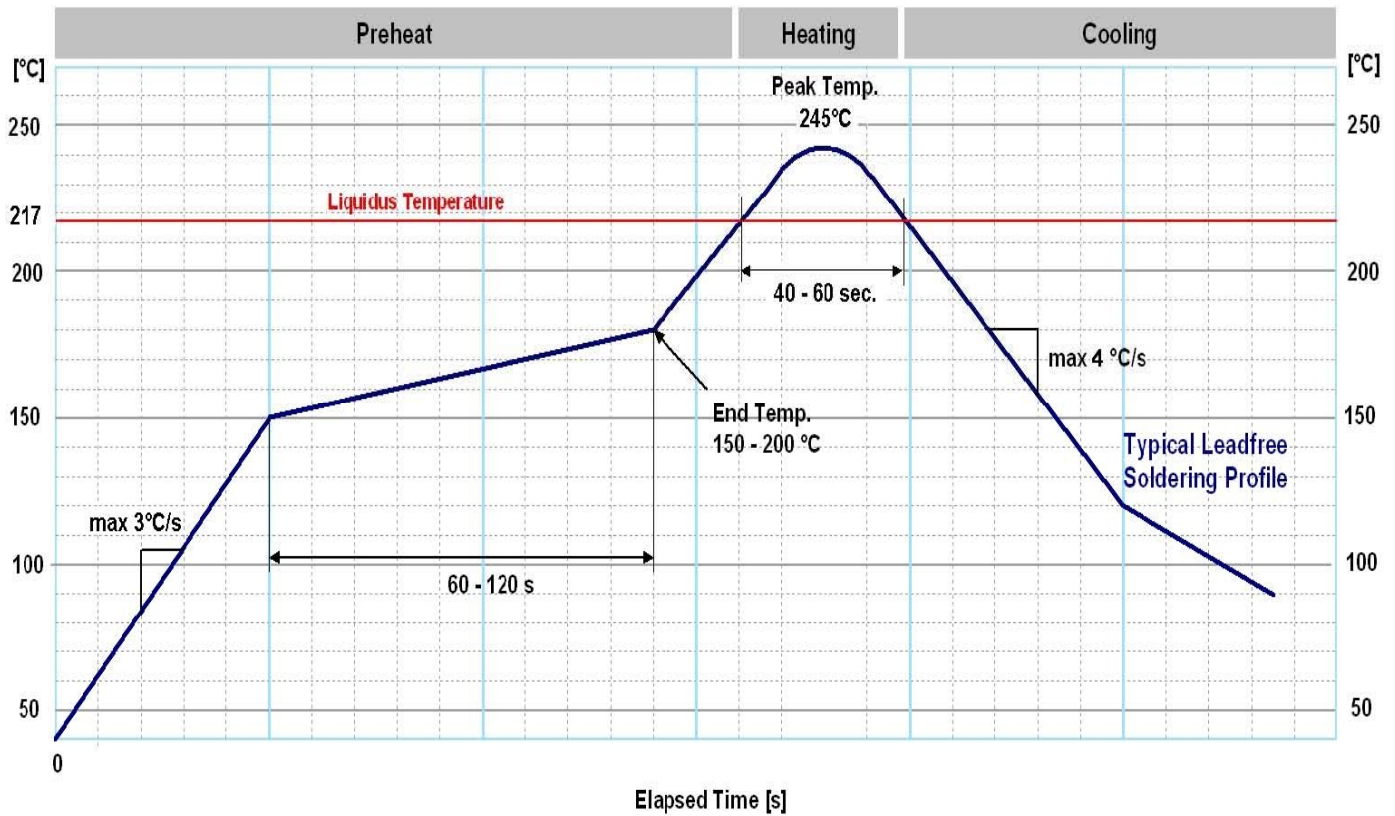

## 8. Tape & Reel (unit : mm)

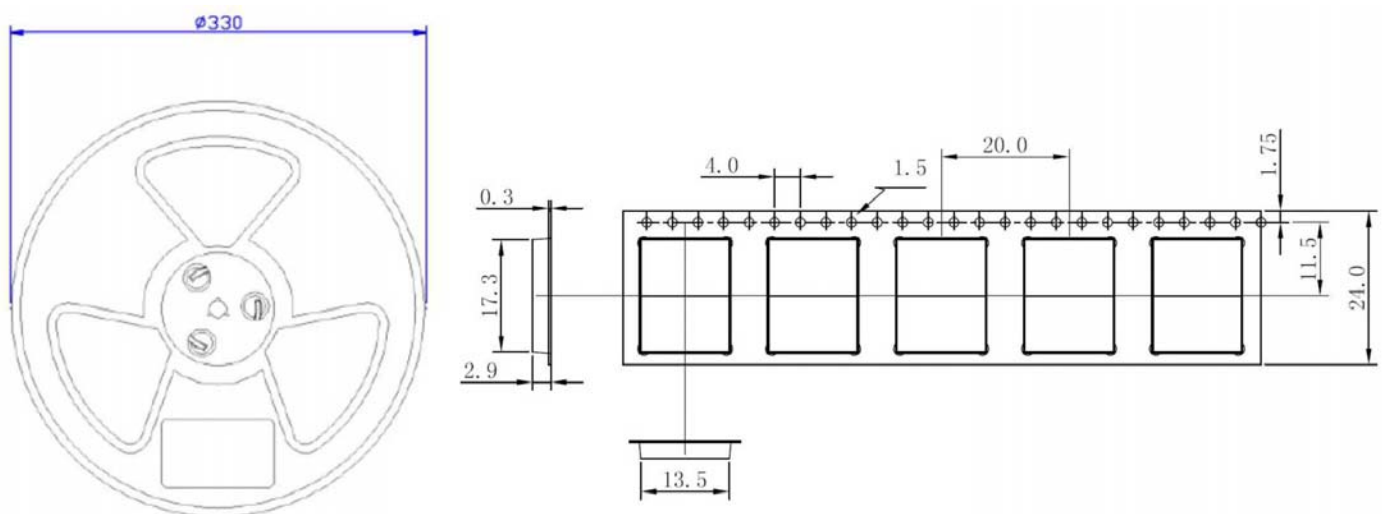

## 9. Software Interface

### NMEA output message

Table 9.1 NMEA output message

NMEA	Description
GGA	Global positioning system fixed data
GLL	Geographic position - latitude/longitude
GSA	GNSS DOP and active satellites
GSV	GNSS satellites in view
RMC	Recommended minimum specific GNSS data
VTG	Course over ground and ground speed

## GGA--- Global Positioning System Fixed Data

Table 9.2 contains the values for the following example:

\$GPGGA,060406.000,2503.7148,N,12138.7451,E,2,17,0.71,116.7,M,15.3,M,0000,0000\*6D

Table 9.2 GGA Data Format

Name	Example	Units	Description
Message ID	\$GPGGA		GGA protocol header
UTC Time	060406.000		hhmmss.sss
Latitude	2503.7148		ddmm.mmmm
N/S indicator	N		N=north or S=south
Longitude	12138.7451		dddmm.mmmm
E/W Indicator	E		E=east or W=west
Position Fix Indicator	2		See Table 9.3
Satellites Used	17		Range 0 to 33
HDOP	0.71		Horizontal Dilution of Precision
MSL Altitude	116.7	mters	
Units	M	mters	
Geoid Separation	15.3	mters	
Units	M	mters	
Age of Diff. Corr.	0000	second	Null fields when DGPS is not used
Diff. Ref. Station ID	0000		
Checksum	*6D		
<CR> <LF>			End of message termination

Table 9.3 Position Fix Indicators

Value	Description
0	Fix not available or invalid
1	GPS SPS Mode, fix valid
2	Differential GPS, SPS Mode, fix valid
3-5	Not supported
6	Dead Reckoning Mode, fix valid

## GLL--- Geographic Position – Latitude/Longitude

Table 9.4 contains the values for the following example:

\$GNGLL,2503.7148,N,12138.7451,E,060406.000,A,D\*46

Table 9.4 GLL Data Format

Name	Example	Units	Description
Message ID	\$GNGLL		GLL protocol header (GPGLL or GNGLL; GP indicates the device receives GPS satellites signal only and GN indicates the position is calculated with BEIDOU satellite signal)
Latitude	2503.7148		ddmm.mmmm
N/S indicator	N		N=north or S=south
Longitude	12138.7451		dddmm.mmmm
E/W indicator	E		E=east or W=west
UTC Time	060406.000		hhmmss.sss
Status	A		A=data valid or V=data not valid
Mode	D		A=autonomous, D=DGPS, E=DR, N=Data not valid, R=Coarse Position, S=Simulator
Checksum	*46		
<CR> <LF>			End of message termination

## GSA---GNSS DOP and Active Satellites

Table 9.5 contains the values for the following example:

\$GNGSA,A,3,22,21,18,12,24,25,14,15,193,,,,,1.18,0.71,0.95\*2C

\$GNGSA,A,3,205,207,210,202,201,203,209,208,,,,,1.18,0.71,0.95\*1C

Table 9.5 GSA Data Format

Name	Example	Units	Description
Message ID	\$GNGSA		GSA protocol header (GNGSA or GPGSA; GP indicates the device receives GPS satellites signal only and GN indicates the position is calculated with BEIDOU satellite signal).First row of GSA message contains GPS & QZSS satellites and second row of GSA message contains BEIDOU satellites.
Mode 1	A		See Table 9.6
Mode 2	3		See Table 9.7
ID of satellite used	22		Sv on Channel 1
ID of satellite used	21		Sv on Channel 2
....			....
ID of satellite used			Sv on Channel 12
PDOP	1.18		Position Dilution of Precision
HDOP	0.71		Horizontal Dilution of Precision
VDOP	0.95		Vertical Dilution of Precision
Checksum	*2C		
<CR> <LF>			End of message termination

Table 9.6 Mode 1

Value	Description
M	Manual- forced to operate in 2D or 3D mode
A	Automatic-allowed to automatically switch 2D/3D

Table 9.7 Mode 2

Value	Description
1	Fix not available
2	2D
3	3D

## GSV---GNSS Satellites in View

Table 9.8 contains the values for the following example:

\$GPGSV,6,1,21,18,78,169,36,209,72,273,36,22,63,309,38,207,63,328,38\*7B

\$GPGSV,6,2,21,203,58,205,39,25,56,138,39,201,55,141,34,206,50,168,\*45

\$GPGSV,6,3,21,210,49,282,34,12,48,076,39,204,39,118,,14,38,322,37\*77

\$GPGSV,6,4,21,193,37,180,34,202,36,246,29,24,23,041,34,31,21,244,\*71

\$GPGSV,6,5,21,21,17,198,33,205,16,258,28,15,12,092,33,208,09,169,30\*7B

\$GPGSV,6,6,21,51,,,\*7E

Table 9.8 GSV Data Format

Name	Example	Units	Description
Message ID	\$GPGSV		GSV protocol header
Total number of messages1	6		Range 1 to 6
Message number1	1		Range 1 to 6
Satellites in view	21		
Satellite ID	18		Channel 1 (Range 01 to 237), GPS Satellites ID : 01~32,SBAS Satellites ID : 33~64, QZSS Satellites ID:193~196, &BEIDOU Satellites ID : 201~214
Elevation	78	degrees	Channel 1 (Range 00 to 90)
Azimuth	169	degrees	Channel 1 (Range 000 to 359)
SNR (C/No)	36	dB-Hz	Channel 1 (Range 00 to 99, null when not tracking)
....	....	....	....
Satellite ID	207		Channel 4 (Range 01 to 237) , GPS Satellites ID : 01~32,SBAS Satellites ID : 33~64, QZSS Satellites ID:193~196, &BEIDOU Satellites ID : 201~214
Elevation	63	degrees	Channel 4 (Range 00 to 90)
Azimuth	328	degrees	Channel 4 (Range 000 to 359)
SNR (C/No)	38	dB-Hz	Channel 4 (Range 00 to 99, null when not tracking)
Checksum	*7B		
<CR> <LF>			End of message termination

Depending on the number of satellites tracked multiple messages of GSV data may be required.

## RMC---Recommended Minimum Specific GNSS Data

Table 9.9 contains the values for the following example:

\$GNRMC,060406.000,A,2503.7148,N,12138.7451,E,0.01,0.00,180313,,D\*78

Table 9.9 RMC Data Format

Name	Example	Units	Description
Message ID	\$GNRMC		RMC protocol header (GNRMC or GPRMC; GP indicates the device receives GPS satellites signal only and GN indicates the position is calculated with BEIDOU satellite signal)
UTC Time	060406.000		hhmmss.sss
Status	A		A=data valid or V=data not valid
Latitude	2503.7148		ddmm.mmmm
N/S Indicator	N		N=north or S=south
Longitude	12138.7451		dddmm.mmmm
E/W Indicator	E		E=east or W=west
Speed over ground	0.01	knots	True
Course over ground	0.00	degrees	
Date	180313		ddmmyy
Magnetic variation		degrees	
Variation sense			E=east or W=west (Not shown)
Mode	D		A=autonomous, D=DGPS, E=DR, N=Data not valid, R=Coarse Position, S=Simulator
Checksum	*78		
<CR> <LF>			End of message termination



## VTG---Course Over Ground and Ground Speed

Table 9.10 contains the values for the following example:

\$GPVTG,0.00,T,,M,0.01,N,0.02,K,D\*3B

Table 9.10 VTG Data Format

Name	Example	Units	Description
Message ID	\$GPVTG		VTG protocol header
Course over ground	0.00	degrees	Measured heading
Reference	T		True
Course over ground		degrees	Measured heading
Reference	M		Magnetic
Speed over ground	0.01	knots	Measured speed
Units	N		Knots
Speed over ground	0.02	km/hr	Measured speed
Units	K		Kilometer per hour
Mode	D		A=autonomous, D=DGPS, E=DR, N=Data not valid, R=Coarse Position, S=Simulator
Checksum	*3B		
<CR> <LF>			End of message termination